

Beam Ducts and Vents in Beams Installation Instructions

General Tools and Materials:

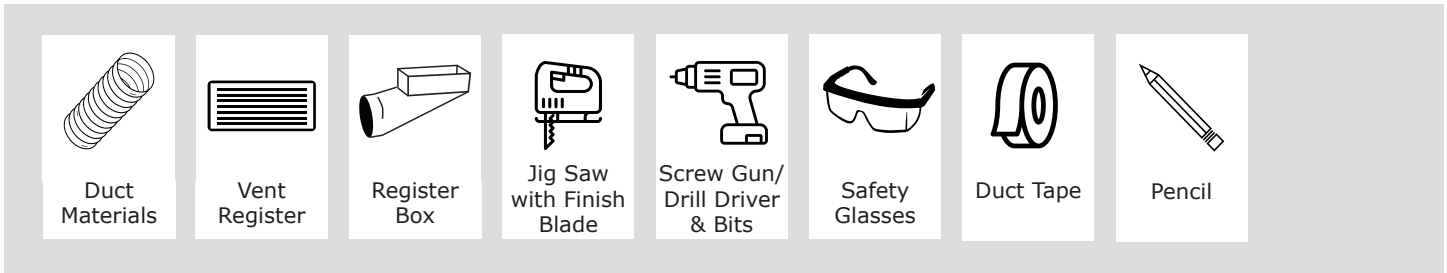

Installation Overview

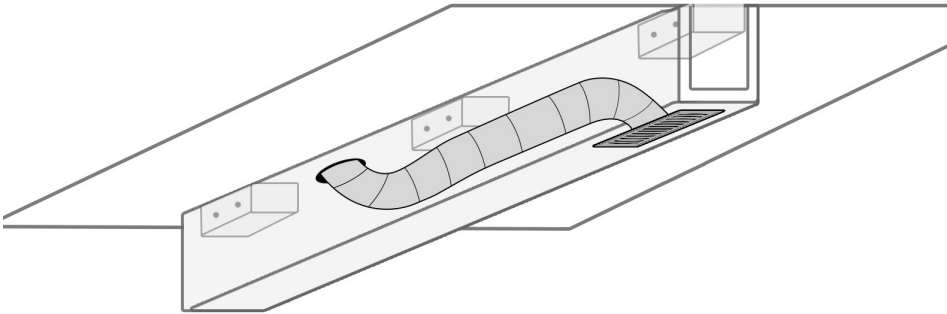

WARNINGS:

- Be sure to obey all safety rules and recommendations set forth by tool manufacturers.
- Follow local building and fire codes.
- Duct work needs to be connected prior to installing the beam and vent.
- Wear safety glasses during the entire installation process.
- Beams are for decorative purposes only. They are not to be used for structural support, bracing or suspension of objects.
- Beams are for decorative purposes only. They are not to be used for structural support, bracing or suspension of objects.

1 Dry Fit Beam

Dry fit the duct work inside the beam to ensure adequate space and clearance for the duct work and mounting blocks needed to install the beam.

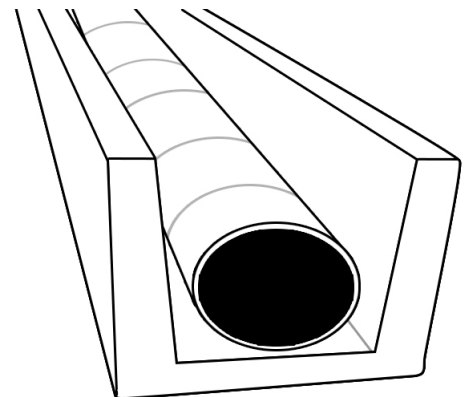

Ducts and Vents in Beams Installation Instructions

2 Template Vent Register Box

Establish where the vent is being placed and the size hole that you need.

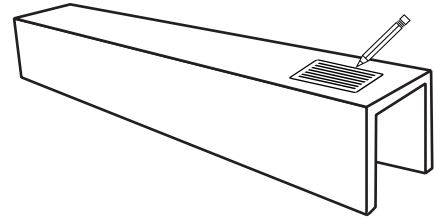

3 Cut Holes

1. Drill pilot holes in each corner.
2. Cut out the vent opening using a jig saw with a finish blade.

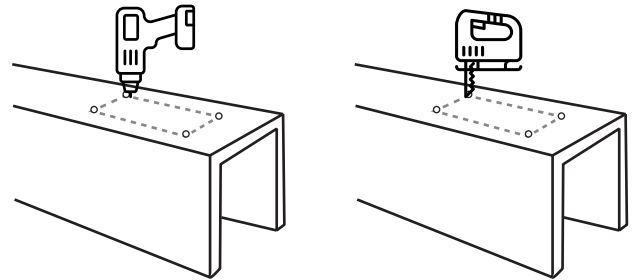

4 Insert Register Box and Vent Register

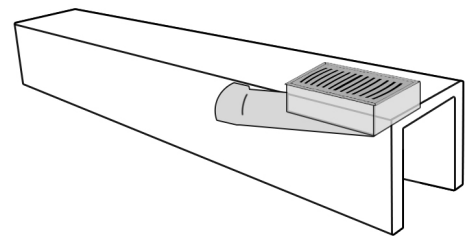

5 Connect Duct Work

Connect duct work prior to completing the beam installation.

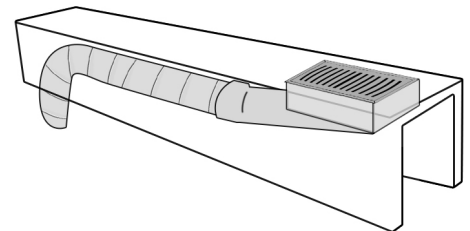

6 Install Beam

Install the beam based on the appropriate installation guide (available on our website). Ensure that all duct work is connected prior to gluing and screwing the beam in place.

